

Product Code

1070/5S

Solenoid Valve
5/8" Flare w/o Coil
PS = 45 bar

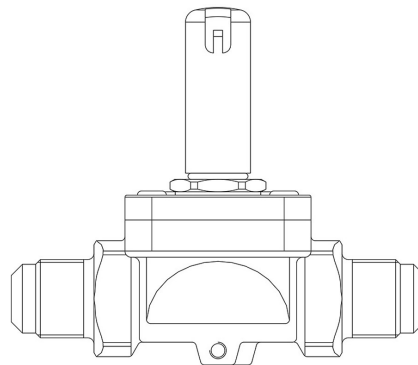

CLASSIC

Product use

Accessories for use with the following ASHRAE 34:2019 refrigerants, Class A1:

HCFC (R22)

HFC (R134a, R404A, R407C, R410A, R507)

HFO (R1234ze)

HFO + HFC (R448A, R449A, R450A, R452A, R513A, R515A, R515B)

These valves are sold in both the version without the coil (S suffix) and the version with the coil (A6 suffix for coils at 220 VAC and A7 suffix for coils at 240 VAC).

Product details

Principio de funcionamiento	Servomandode membrana
Dibujo	img(1070_4S.jpg)
N° catálogo	1070/5S
Tipo Bobina (1)	HF2HF3HF4HM2HM3HM4CM2
Conexiones SAE flare	5/8"
Kv [m³/h]	2,61
PS [bar]	45
TS [°C] min.	-35
TS [°C] max.	+105
Paquete de n° piezas	24

Notes

(1) bobinas que pueden montarse en las válvulas