

Product Code

1050/5S

Solenoid Valve
5/8" Flare w/o Coil
PS = 45 bar

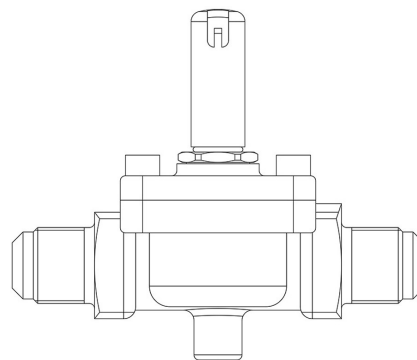

CLASSIC

Product use

Accessories for use with the following ASHRAE 34:2019 refrigerants, Class A1:

HCFC (R22)

HFC (R134a, R404A, R407C, R410A, R507)

HFO (R1234ze)

HFO + HFC (R448A, R449A, R450A, R452A, R513A, R515A, R515B)

These valves are sold in both the version without the coil (S suffix) and the version with the coil (A6 suffix for coils at 220 VAC and A7 suffix for coils at 240 VAC).

Product details

Principio de funcionamiento Servomando de pistón

Dibujo img(1050_5S.jpg)

N° catálogo 1050/5S

Tipo Bobina (1) HF2HF3HF4HM2HM3HM4CM2

Conexiones SAE flare 5/8"

Kv [m³/h] 3,8

PS [bar] 45

TS [°C] min. -35

TS [°C] max. +110

Paquete de n° piezas 14

Notes

(1) bobinas que pueden montarse en las válvulas