

Product Code

1038/3S

Solenoid Valve
3/8"ODS w/o Coil
PS = 45 bar

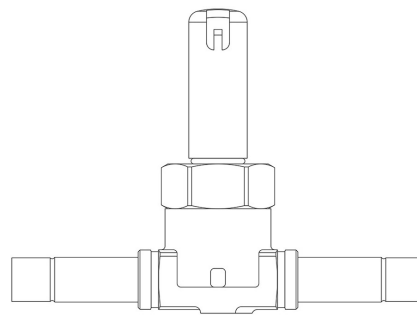

CLASSIC

Product use

Accessories for use with the following ASHRAE 34:2019 refrigerants, Class A1:

HCFC (R22)

HFC (R134a, R404A, R407C, R410A, R507)

HFO (R1234ze)

HFO + HFC (R448A, R449A, R450A, R452A, R513A, R515A, R515B)

These valves are sold in both the version without the coil (S suffix) and the version with the coil (A6 suffix for coils at 220 VAC and A7 suffix for coils at 240 VAC).

Product details

Principio de funcionamiento	Servomando de pistón
Dibujo	img(1038_3S.jpg)
N° catálogo	1038/3S
Tipo Bobina (1)	HF2HF3HF4HM2HM3HM4CM2
Conexiones ODS Ø [in.]	3/8"
Conexiones ODS Ø [mm]	-
Kv [m³/h]	1
PS [bar]	45
TS [°C] min.	-35
TS [°C] max.	+110

Notes

(1) bobinas que pueden montarse en las válvulas