

Product Code

1038/3A6

Solenoid Valve
3/8"ODS 220-230V
PS = 45 bar

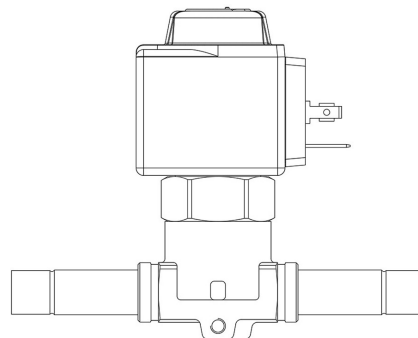

CLASSIC

Product use

Accessories for use with the following ASHRAE 34:2019 refrigerants, Class A1:

HCFC (R22)

HFC (R134a, R404A, R407C, R410A, R507)

HFO (R1234ze)

HFO + HFC (R448A, R449A, R450A, R452A, R513A, R515A, R515B)

These valves are sold in both the version without the coil (S suffix) and the version with the coil (A6 suffix for coils at 220 VAC and A7 suffix for coils at 240 VAC).

Product details

Principio de funcionamiento Servomando de pistón

Dibujo img(1038_3A6.jpg)

N° catálogo 1038/3A6

Tipo Bobina (1) HF2

Conexiones ODS Ø [in.] 3/8"

Conexiones ODS Ø [mm] -

Kv [m³/h] 1

PS [bar] 45

TS [°C] min. -35

TS [°C] max. +110

Notes

(1) : bobinas montadas en las válvulas