

Product Code

6110N/43

Receiver Valve
1/2"Flarex3/8"NPT
PS = 50 bar

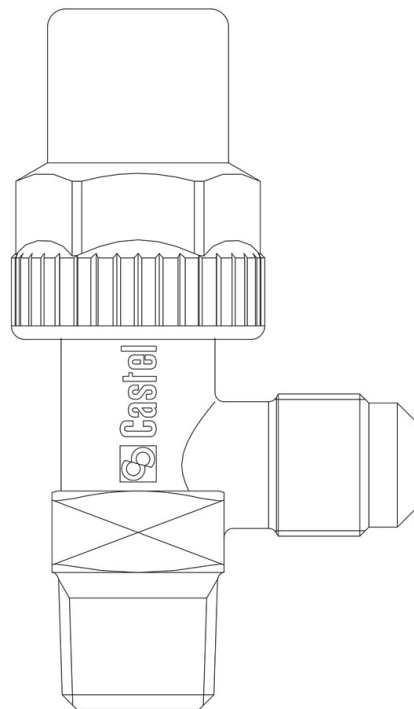

Product use

Accessories for use with the following ASHRAE 34:2019 refrigerants, Class A1, A2L, or A3:
 HFC (R134A, R32, R404A, R407C, R410A, R507)
 HFO (R1234YF, R1234ZE)
 HFO + HFC (R448A, R449A, R450A, R452A, R452B, R454A, R454B, R454C, R455A, R513A, R515A, R515B)
 HC (R290, R600, R600A, R1270)

Product details

Dibujo img(6110N_22.jpg)

N° catálogo 6110N/43

Obús de carga SAE Flare -

Conexiones SAE Flare 1/2"

Conexiones NPT 3/8"

Kv [m³/h] 2,4

PS [bar] 50

TS [°C] min. -40

TS [°C] max. +150

Paquete de n° piezas 20