

Product Code

6110/23

Receiver Valve
1/4"Flarex3/8"NPT
PS = 45 bar

CLASSIC

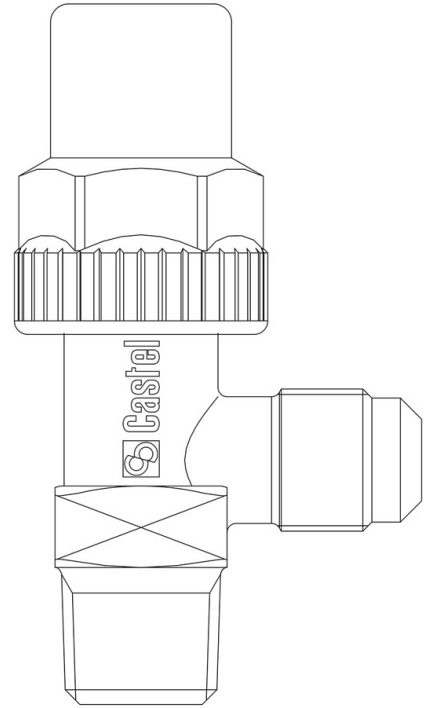

Product use

Accessories for use with the following ASHRAE 34:2019 refrigerants, Class A1:

HCFC (R22)

HFC (R134a, R404A, R407C, R410A, R507)

HFO (R1234ze)

HFO + HFC (R448A, R449A, R450A, R452A, R513A, R515A, R515B)

Product details

Dibujo img(6110_21.jpg)

N° catálogo 6110/23

Obús de carga SAE Flare -

Conexiones SAE Flare 1/4"

Conexiones NPT 3/8"

Kv [m³/h] 0,45

PS [bar] 45

TS [°C] min. -40

TS [°C] max. +130

Paquete de n° piezas 90