

Product Code

3125N/13

Check Valve
1.5/8" ODS
PS = 50 bar

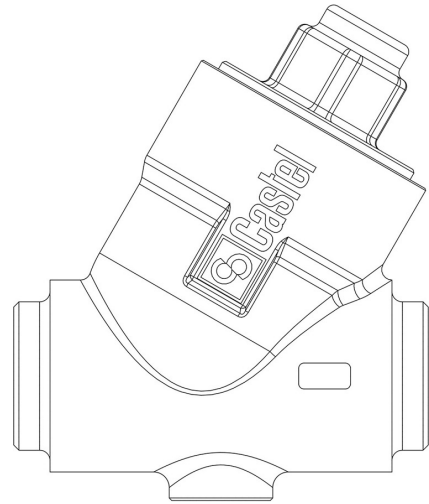

P  **LYHEDRA**

Product use

Accessories for use with the following ASHRAE 34:2019 refrigerants, Class A1, A2L, or A3:
 HFC (R134A, R32, R404A, R407C, R410A, R507)
 HFO (R1234YF, R1234ZE)
 HFO + HFC (R448A, R449A, R450A, R452A, R452B, R454A, R454B, R454C, R455A, R513A, R515A, R515B)
 HC (R290, R600, R600A, R1270)

Product details

Dibujo img(3124N_7.jpg)

N° catálogo 3125N/13

Conexiones ODS Ø [in.] 1.5/8"

Conexiones ODS Ø [mm] -

ODM Ø [in.] 2"

ODM Ø [mm] -

Kv [m³/h] 27

Presión diferencial (1) [bar] 0,3

PS [bar] 50

TS [°C] min. -40

TS [°C] max. +150

Notes

(1) Mínima presión con la cual la válvula está totalmente abierta