

Product Code

6210/6

Diaphragm Valve

3/4"Flare

PS = 28 bar

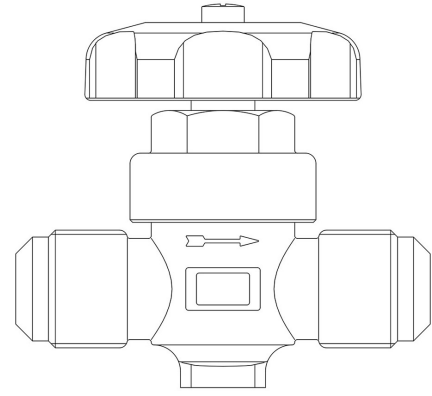

CLASSIC

Product use

Accessories for use with the following ASHRAE 34:2019 refrigerants, Class A1:

HCFC (R22)

HFC (R134a, R404A, R407C, R410A, R507)

HFO (R1234ze)

HFO + HFC (R448A, R449A, R450A, R452A, R513A, R515A, R515B)

Product details

Dibujo img(6210_2.jpg)

N° catálogo 6210/6

Conexiones SAE Flare 3/4"

Conexiones ODS Ø [in.] -

ODS Ø [mm] -

Kv [m³/h] 3,65

PS[bar] 28

TS[°C] min. -35

TS[°C] max. +90

Paquete de n° piezas 14