

## Product Code

# 2028E/M12S08

12mmx16mm ODS Seat 08  
12mmx16mm ODS Orificio 08  
PS = 90 bar

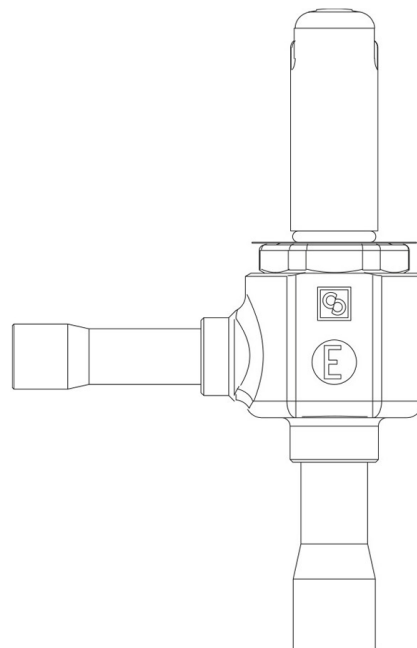

### Product use

Accessories for use with refrigerant R744.

These valves are only sold in the model without the coil (S suffix), with 9 nozzles assembled for an increasing output from 2 to 43 kW.

### Product details

**Dibujo** img(2028E\_3S01.jpg)

**N° catálogo** 2028E/M12S08

**Tipo orificio** 08

**Conexiones In Ø [in.]** -

**Conexiones In Ø [mm]** 12

**Out Ø [in.]** -

**Out Ø [mm]** 16

**Kv [m<sup>3</sup>/h]** 0,23

**PS [bar]** 90

**MWP [psi] (1)** 1305

**TS [°C] min. min.** -50

**TS [°C] max. max.** +100

**Paquete de n° piezas** 17

## Notes

(1): en conformidad con la homologación UL