

Product Code

2028E/4S08

1/2"x5/8"ODS Seat 08

1/2"x5/8"ODS Orificio 08

PS = 90 bar

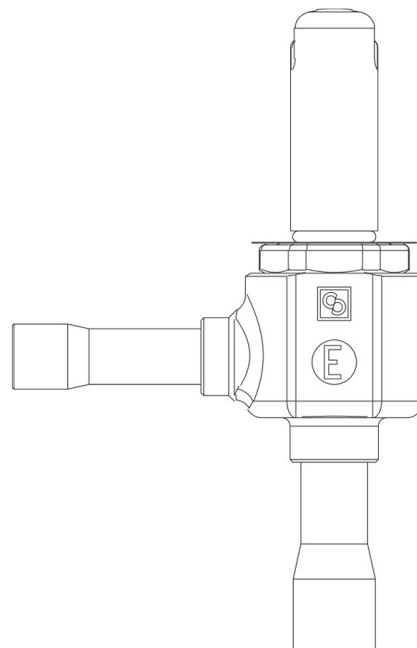

Product use

Accessories for use with refrigerant R744.

These valves are only sold in the model without the coil (S suffix), with 9 nozzles assembled for an increasing output from 2 to 43 kW.

Product details

Dibujo img(2028E_3S01.jpg)

N° catálogo 2028E/4S08

Tipo orificio 08

Conexiones In Ø [in.] 1/2"

Conexiones In Ø [mm] -

Out Ø [in.] 5/8"

Out Ø [mm] -

Kv [m³/h] 0,23

PS [bar] 90

MWP [psi] (1) 1305

TS [°C] min. min. -50

TS [°C] max. max. +100

Paquete de n° piezas 17

Notes

(1): en conformidad con la homologación UL