

Product Code

2028E/3S04

3/8"x1/2"ODS Seat 04

3/8"x1/2"ODS Orificio 04

PS = 90 bar

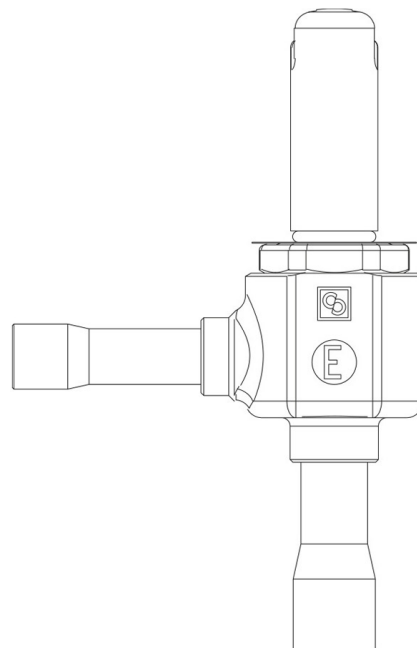

Product use

Accessories for use with refrigerant R744.

These valves are only sold in the model without the coil (S suffix), with 9 nozzles assembled for an increasing output from 2 to 43 kW.

Product details

Dibujo img(2028E_3S01.jpg)

N° catálogo 2028E/3S04

Tipo orificio 04

Conexiones In Ø [in.] 3/8"

Conexiones In Ø [mm] -

Out Ø [in.] 1/2"

Out Ø [mm] -

Kv [m³/h] 0,043

PS [bar] 90

MWP [psi] (1) 1305

TS [°C] min. min. -50

TS [°C] max. max. +100

Paquete de n° piezas 17

Notes

(1): en conformidad con la homologación UL