

## Product Code

# 2028/M10S01

PWM Expansion Valve  
10mmx12mm ODS Seat 01  
PS = 45 bar

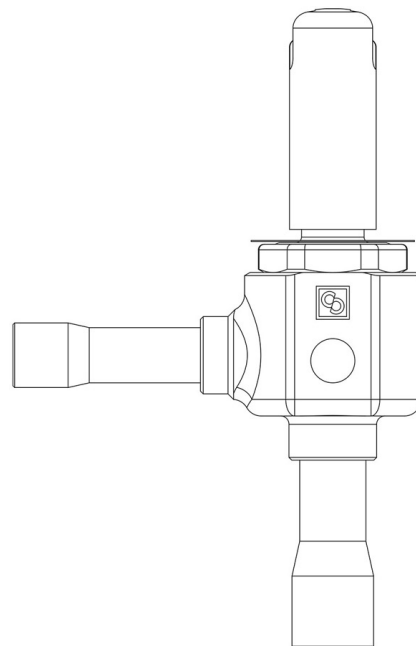

CLASSIC

### Product use

Accessories for use with the following ASHRAE 34:2019 refrigerants, Class A1:

HCFC (R22)

HFC (R134a, R404A, R407C, R410A, R507)

HFO (R1234ze)

HFO + HFC (R448A, R449A, R450A, R452A, R513A,  
R515A, R515B)

These valves are only sold in the model without the coil (S suffix), with 9 nozzles assembled for an increasing output from 1 to 22 kW with R410A.

### Product details

Dibujo img(2028\_3S01.jpg)

N° catálogo 2028/M10S01

Tipo orificio 01

Conexiones In Ø [in.] -

Conexiones In Ø [mm] 10

Out Ø [in.] -

Out Ø [mm] 12

Kv [m<sup>3</sup>/h] 0,01

PS [bar] 45

TS [°C] min.	-40
TS [°C] max.	+100
Paquete de n° piezas	17

## Notes

para capacidades nominales ver tabla de grupos de orificios