

Product Code

2028/3S02

PWM Expansion Valve
3/8"x1/2" ODS Seat 02
PS = 45 bar

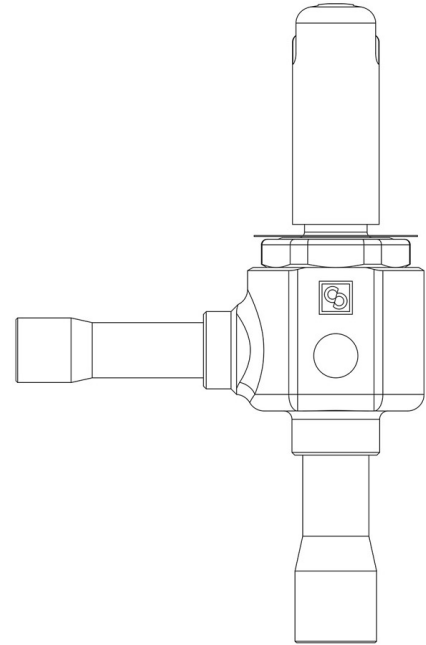

CLASSIC

Product use

Accessories for use with the following ASHRAE 34:2019 refrigerants, Class A1:

HCFC (R22)

HFC (R134a, R404A, R407C, R410A, R507)

HFO (R1234ze)

HFO + HFC (R448A, R449A, R450A, R452A, R513A,
R515A, R515B)

These valves are only sold in the model without the coil (S suffix), with 9 nozzles assembled for an increasing output from 1 to 22 kW with R410A.

Product details

Dibujo img(2028_3S01.jpg)

N° catálogo 2028/3S02

Tipo orificio 02

Conexiones In Ø [in.] 3/8"

Conexiones In Ø [mm] -

Out Ø [in.] 1/2"

Out Ø [mm] -

Kv [m³/h] 0,017

PS [bar] 45

TS [°C] min.	-40
TS [°C] max.	+100
Paquete de n° piezas	17

Notes

para capacidades nominales ver tabla de grupos de orificios