

Product Code

6410/2

Capped Valve

1/4" Flare

PS = 45 bar

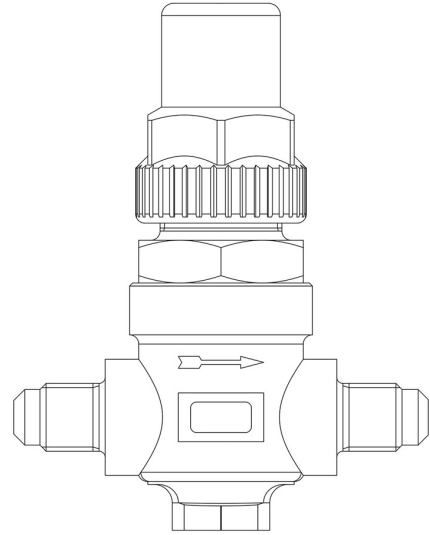

CLASSIC

Product use

Accessories for use with the following ASHRAE 34:2019 refrigerants, Class A1:

HCFC (R22)

HFC (R134a, R404A, R407C, R410A, R507)

HFO (R1234ze)

HFO + HFC (R448A, R449A, R450A, R452A, R513A, R515A, R515B)

Product details

Dibujo img(6410_2.jpg)

N° catálogo 6410/2

Conexiones SAE Flare 1/4"

Conexiones ODS Ø [in.] -

ODS Ø [mm] -

Kv [m³/h] 0,4

PS[bar] 45

TS[°C] min. -40

TS[°C] max. +110

Paquete de n° piezas 45