

Product Code

6690NM/M10A2

3-Ways Motorized Ball Valve-polyhedra

10mm ODS 24V

PS = 50 bar

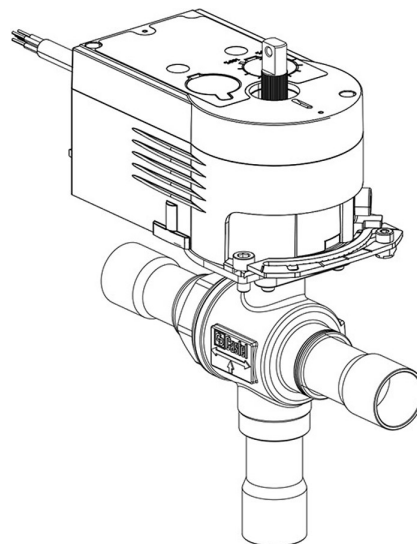

Product use

Accessories for use with the following ASHRAE 34:2019 refrigerants, Class A1, A2L, A3:

HFC (R134A, R32, R404A, R407C, R410A, R507)

HFO (R1234YF, R1234ZE)

HFO + HFC (R448A, R449A, R450A, R452A, R452B, R454A, R454B, R454C, R455A, R513A, R515A, R515B)

HC (R290, R600, R600A, R1270)

Product details

Dibujo img(6690NM_7A2.jpg)

N° catálogo (1) 6690NM/M10A2

N° catálogo (1)

Conexiones ODS Ø [in.] -

Conexiones ODS Ø [mm] 10

Potencia W Ø [mm] -

P/N Servomotor 9700/RA2

Torque [Nm] 10

Orificio Bola Ø [mm] 13,5

Kv [m³/h] 4,6

PS [bar] 50

TS [°C] min. -40

TS [°C] max. +150

Notes

NB: versiones de flujo proporcional disponibles

(1): completo con servomotores y placa de montaje