

Product Code

6690M/M42A2

3-Ways Motorized Ball Valve

42mm ODS 24V

PS = 45 bar

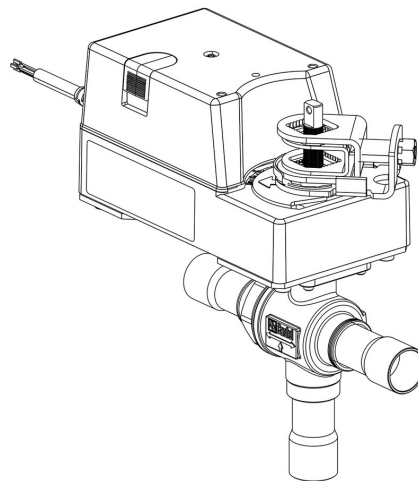

CLASSIC

Product use

Accessories for use with the following ASHRAE 34:2019 refrigerants, Class A1:

HCFC (R22)

HFC (R134a, R404A, R407C, R410A, R507)

HFO (R1234ze)

HFO + HFC (R448A, R449A, R450A, R452A, R513A, R515A, R515B)

Product details

Dibujo img(6690M_11A2.jpg)

N° catálogo (1) 6690M/M42A2

N° catálogo (1)

Conexiones ODS Ø [in.] -

Conexiones ODS Ø [mm] 42

W Ø [mm] -

P/N Servomotor 9720/RA2

Torque [Nm] 30

Orificio Bola Ø [mm] 37

Kv[m³/h] 38,5

PS[bar] 45

TS[°C] min.	-40
TS[°C] max.	+150
Paquete de n° piezas	1

Notes

NB: versiones de flujo proporcional disponibles
(1): completo con servomotores y placa de montaje