

Product Code

3070/44C370

Bursting Disc Safety Device
1/2"x1/2"NPT Pset=37,0bar
PS = 55 bar

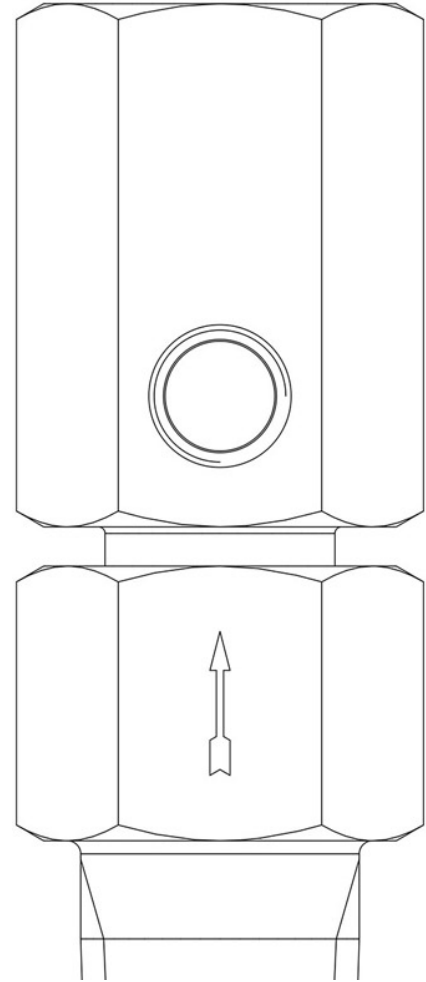

Product use

Safety device 3070 is a pressure relief device that cannot be closed again, in which a bursting disc is sensitive to a positive differential pressure between the upstream and downstream sections. It is designed to burst at a specified pressure.

Safety accessories for use with the following ASHRAE 34:2019 refrigerants, Class A1:

HCFC (R22)

HFC (R134a, R404A, R407C, R410A, R507)

HFO (R1234ze)

HFO + HFC (R448A, R449A, R450A, R452A, R513A, R515A, R515B)

Available at various burst pressures from 14 to 52 bar.

Product details

Dibujo img(3070_44C.jpg)

N° catálogo 3070/44C370

Conexiones IN machio 1/2" NPT

Conexiones OUT femmina 1/2" NPT

servicio 2 x 1/8" NPT

Sección orificio [mm²] 113

Presión de rotura Pb [bar] 37

Presión máx. de ejercicio	75 % Pb
PS[bar]	55
TS[°C] min.	-50
TS[°C] max.	+150
Paquete de n° piezas	20