

Product Code

3082/2C

Fusible Plug

1/4"NPT T=138° C

PS = 30 bar

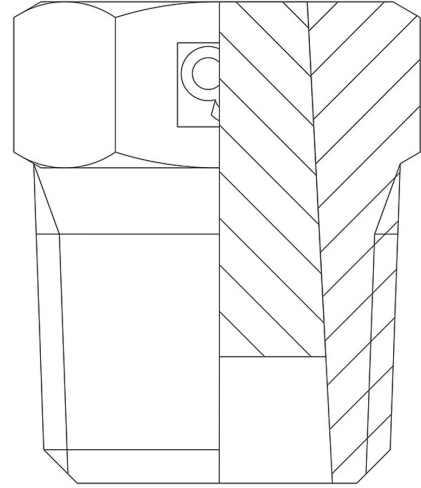

CLASSIC

Product use

Fusible plugs are safety devices that contain a material that melts at a specific temperature and consequently vents the pressure. Safety accessories for use with the following ASHRAE 34:2019 refrigerants, Class A1:

HCFC (R22)

HFC (R134a, R404A, R407C, R410A, R507)

HFO (R1234ze)

HFO + HFC (R448A, R449A, R450A, R452A, R513A, R515A, R515B)

Alloy melting point 79 °C for plugs in series 3080. Alloy melting point 138 °C for plugs in series 3082.

Product details

Dibujo 

N° catálogo 3082/2C

Conexiones NPT 1/4"

Sección orificio [mm²] 25,5

Kd 0,91

PS[bar] 30

Temperatura de fusión [°C] 138

Temperatura máx. de ejercicio [°C] 127

Paquete de n° piezas 0