

Product Code

7030/2M5

Nut

1/4"FlarexPipe5mm

PS = 50 bar

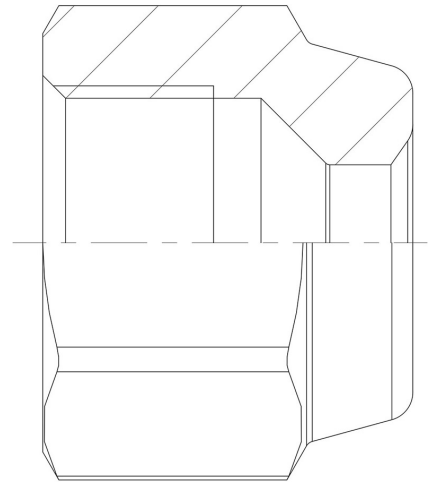

Product use

Accessories for use with the following ASHRAE 34:2019 refrigerants, Class A1, A2L, or A3:

- HCFC (R22)
- HFC (R134a, R32, R404A, R407C, R410A, R507)
- HFO and HFO/HFC blends (R1234ze, R1234yf, R448A, R449A, R450A, R452A, R513A, R515A, R515B)
- HC (R290, R600, R600a, R1270)
- R744

Product details

Dibujo 

N° catálogo 7030/2M5

Código internacional -

SAE Flare 1/4"

Tubo de cobre Ø [in.] -

Tubo de cobre Ø [mm] 5

PS [bar] 50

Paquete de n° piezas 100

Notes

(1) rebajado