

Product Code

9320/RD2

Coil Type HF3
24VDC

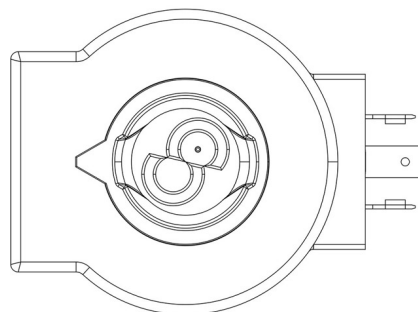
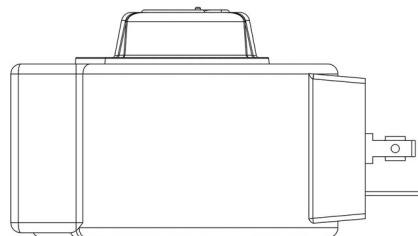

Product use

Coils with the new ?FAST LOCK? fixing system, series 9320, and coils with gear fixing systems, series 9120 and 9121 to be used with normally closed solenoid valves.

Fast-on connections type DIN 43650/A for coils in series 9120 and 9320; co-moulded cables for series 9121 coils.

Available voltages: 220/230 VAC - 50/60 Hz, 12 VDC, 24 VDC, 27 VDC, 48 VDC.

Connectors in series 9150, normalized DIN 43650, to wire, with IP65 protection rating. Connectors in series 9900, again normalized DIN 43650, pre-wired with various cable lengths, with IP65 protection rating.

Product details

Dibujo [img\(9320_RA6.jpg\)](#)

Tipo Bobina HF3

N° catálogo 9320/RD2

N° catálogo

Tensión [V] 24 D.C.

Frecuencia [Hz] -

Potencia [W] 20

Longitud cable [m] -

Notes

(1) bobina con repuesto G9150/R97 (anillo amarillo + tornillo negro + OR)