

Product Code

9360/RA2

Coil Type HF4
24V 50/60Hz

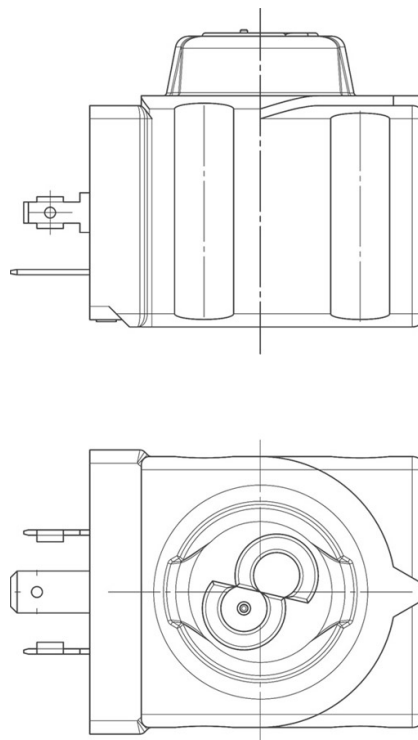

Product use

Coils with the new ?FAST LOCK? fixing system, series 9300 and 9320, and coils with gear fixing systems, series 9110, 9120 and 9160.

Fast-on connections type DIN 43650/A for coils in series: 9120, 9160, 9300 and 9320; co-moulded cables for series 9110 coils. Protection rating IP65; IP68 for series 9160 coils coupled with series 9155 connectors. Available voltages; 24 VAC - 50/60 Hz, 110 VAC - 50/60 Hz, 220/230 VAC - 50/60 Hz, 240 VAC - 50/60 Hz, 380 VAC - 50/60 Hz, 12 VDC, 24 VDC, 27 VDC, 48 VDC.

Connectors in series 9150, normalized DIN 43650, to wire, with IP65 protection rating. Connectors in series 9900, again normalized DIN 43650, pre-wired with various cable lengths, with IP65 protection rating.

Connectors in series 9155, to wire, with IP65/68 protection rating.

Product details

Dibujo [img\(9360_RA6.jpg\)](#)

Tipo Bobina HF4

N° catálogo 9360/RA2

N° catálogo

Tensión [V] 24

Frecuencia [Hz] 50/60

Potencia [W] 8

Longitud cable [m] -

Notes

- (1) bobina con repuesto G9150/R97 (anillo amarillo + tornillo negro + OR)
- (2) Utilizar exclusivamente con conector rectificador 9150/R45