

Product Code

1034N/3A6

Solenoid Valve
3/8" Flare 220-230V
PS = 50 bar

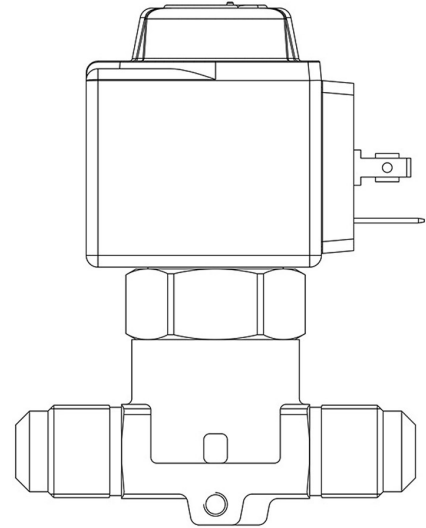

P  **LYHEDRA**

Product use

Accessories for use with the following ASHRAE 34:2019 refrigerants, Class A1, A2L, or A3:
HFC (R134A, R32, R404A, R407C, R410A, R507)
HFO (R1234YF, R1234ZE)
HFO + HFC (R448A, R449A, R450A, R452A, R452B, R454A, R454B, R454C, R455A, R513A, R515A, R515B)
HC (R290, R600, R600A, R1270)

These valves are sold in both the version without the coil (S suffix) and the version with the coil (A6 suffix for coils at 220 VAC).

Product details

Principio di funzionamento Servocomando a pistone

Tipo Bobina (1) HF2

Attacchi SAE Flare 3/8"

Kv [m³/h] 1

PS [bar] 50

TS [°C] min. -40

TS [°C] max. +130

Confezione n° pz 18

Notes

(1) : bobine montate sulle valvole