

Product Code

3133W/4

Check Valve

1/2" ODS

PS = 50 bar - 600 PSI

POLYHEDRA

CLASSIC

Product use

Accessories for use with the following ASHRAE 34:2019 refrigerants, Class A1, A2L, or A3:
 HFC (R134A, R32, R404A, R407C, R410A, R507)
 HFO (R1234YF, R1234ZE)
 HFO + HFC (R448A, R449A, R450A, R452A, R452B, R454A, R454B, R454C, R455A, R513A, R515A, R515B)
 HC (R290, R600, R600A, R1270)

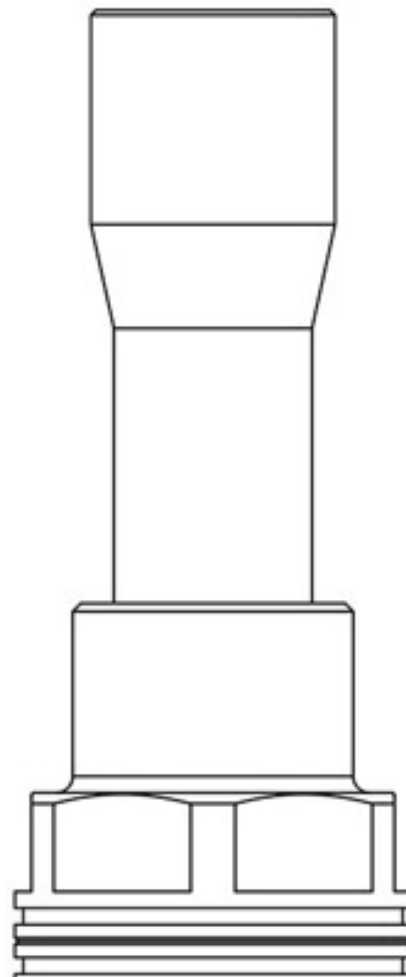

Product details

Attacchi SAE Flare	-
Attacchi ODS Ø [in.]	1/2"
ODS Ø [mm]	-
Kv [m ³ /h]	1,8
Pressione differenziale (2) [bar]	0,3
PS [bar]	50
MWP [psi] (1)	600
TS [°C] min.	-40
TS [°C] max.	+150

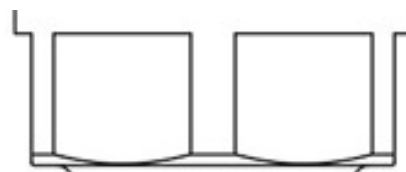

Notes

(1): in conformità a omologazione UL

(2): minima pressione a cui la valvola è completamente aperta