

Product Code

6110E/33

Receiver Valve CO2

3/8"FlareX3/8"NPT
PS = 140 bar

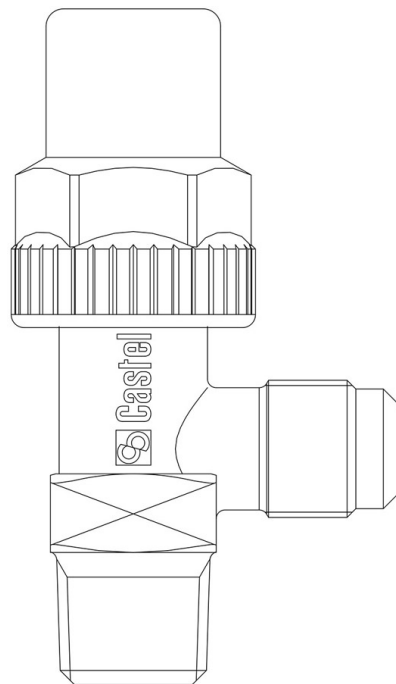

Product use

Accessories for use with refrigerant R744.

Product Details

Connections SAE Flare -

Connections SAE Flare 3/8"

NPT 3/8"

NPT -

Kv [m³/h] 1,35

PS [bar] 140

MWP [psi] (3) 2030

TS [°C] min. -40

TS [°C] max. +130

Package pcs 90

Notes where expressly stated

(1): including a conical gasket 7580/2

(2): can be installed without gasket

(3): according to UL approval