

## Product Code

# 27115/4

Electronic Expansion Valve  
1/2"ODS<br>PS = 50 bar

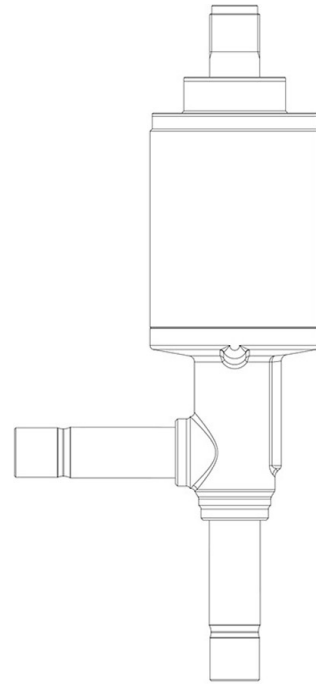

**P**  **LYHEDRA**

### Product use

Castel step-motor expansion valves series 271, 272, 273 regulate the flow of the liquid refrigerant into evaporators by modulating the valve shutter position in a calibrated orifice, allowing a wide capacity regulation range.

Accessories for use with the following ASHRAE 34:2019 refrigerants, Class A1, A2L, or A3:

HFC (R134A, R32, R404A, R407C, R410A, R507)

HFO (R1234YF, R1234ZE)

HFO + HFC (R448A, R449A, R450A, R452A, R452B, R454A, R454B, R454C, R455A, R513A, R515A, R515B)

HC (R290, R600, R600A, R1270)

### Product Details

Connections In Ø [in.] 1/2"

Connections In Ø [mm] -

Out Ø [in.] 1/2"

Out Ø [mm] -

PS [bar] 50

TS [°C] min. -40

TS [°C] max. +60

Castel non si assume alcuna responsabilità per eventuali errori nei cataloghi, opuscoli e altro materiale stampato o indicato nel sito Castel.it. Castel si riserva il diritto di modificare i propri prodotti senza preavviso. Tutti i marchi in questo materiale sono di proprietà di Castel. Tutti i diritti riservati.

Castel assumes no responsibility for any errors in catalogs, brochures and other material printed or indicated on the Castel.it website. Castel reserves the right to modify its products without notice. All trademarks in this material are the property of Castel. All rights reserved.

<b>Voltage [V]</b>	6
<b>Power [W]</b>	2,4
<b>Steps</b>	415
<b>Degree of protection</b>	IP65
<b>Package pcs.</b>	5

## Notes where expressly stated

Bipolar stepper motor with permanent magnets