

Product Code

**7020/40**

Blind Nut

1/2"Flare<br>PS = 140 bar

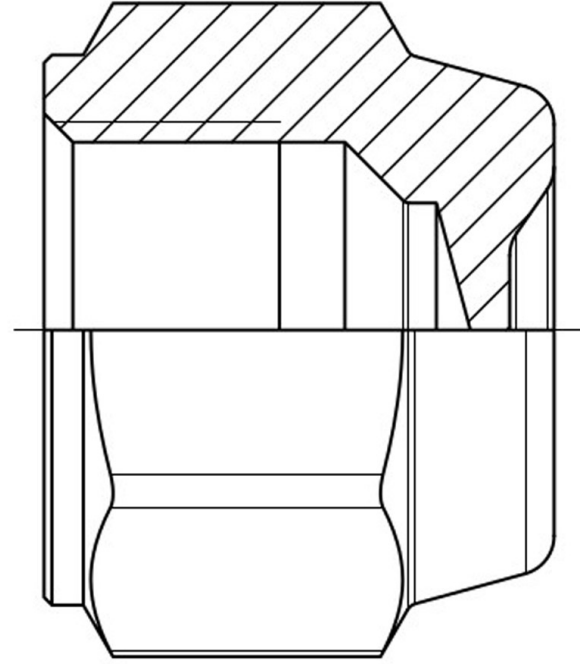

### Product use

Accessories for use with the following ASHRAE 34:2019 refrigerants, Class A1, A2L, or A3:

- HCFC (R22)
- HFC (R134a, R32, R404A, R407C, R410A, R507)
- HFO and HFO/HFC blends (R1234ze, R1234yf, R448A, R449A, R450A, R452A, R513A, R515A, R515B)
- HC (R290, R600, R600a, R1270)
- R744

### Product Details

**International code** N5-8 CAP NUT

**SAE Flare** 1/2"

**Copper Pipe Ø [in.]**

**Copper Pipe Ø [mm]**

**PS [bar]** 140

**Package pcs** 50

### Notes where expressly stated

- (1) Can be used without copper gasket