

Product Code

2028EX/M12A608

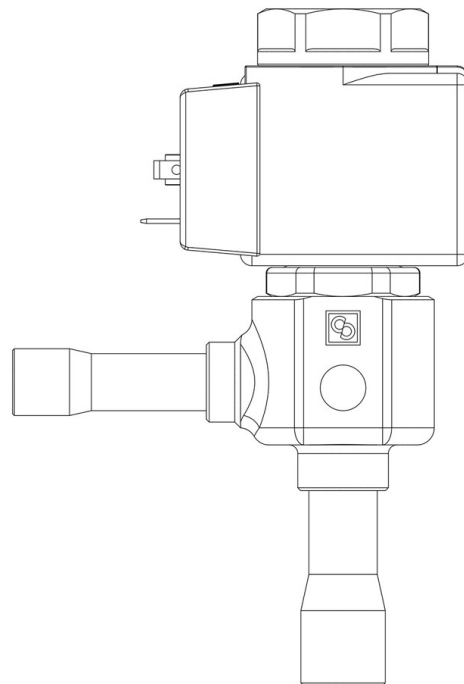

POLYHEDRA

Product use

Solenoid expansion valves with the EX suffix are compliant with the ESR of Directive 2014/34/EU ATEX. This equipment is suitable for use on refrigeration systems located in areas classified as Zone 2 risk of explosion, according to the definition in Annex I of Directive 1999/92/EC.

Accessories for use with the following ASHRAE 34:2019 refrigerants, Class A1, A2L, or A3:

HFC (R134A, R32, R404A, R407C, R410A, R507)

HFO (R1234YF, R1234ZE)

HFO + HFC (R448A, R449A, R450A, R452A, R452B, R454A, R454B, R454C, R455A, R513A, R515A, R515B)

HC (R290, R600, R600A, R1270)

These valves are only sold in the model with the ATEX certified coil (A6 suffix), with 9 nozzles assembled for an increasing output from 2 to 36 kW with R290.

Product Details

Orifice type	08
Connections In Ø [in.]	-
Connections In Ø [mm]	12
Out Ø [in.]	-
Out Ø [mm]	16
Kv [m ³ /h]	0,23
PS [bar]	50
TS [°C] min.	-40

TS [°C] max. +100

Package pcs. 15

Notes where expressly stated

for rated capacities see table of the orifice assemblies