

Product Code

6020/222

Three Ways Hermetic Valve
1/4"Flare
PS = 45 bar

CLASSIC

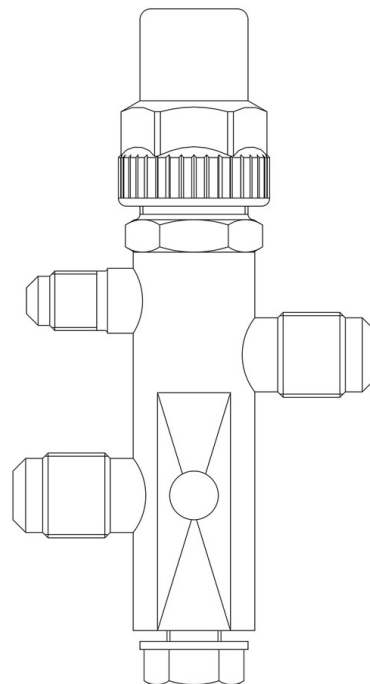

Product use

Accessories for use with the following ASHRAE 34:2019 refrigerants, Class A1:

HCFC (R22)

HFC (R134a, R404A, R407C, R410A, R507)

HFO (R1234ze)

HFO + HFC (R448A, R449A, R450A, R452A, R513A, R515A, R515B)

Product Details

Access fitting SAE Flare 1/4"

Connections SAE Flare Ø [in.] 1/4"

Connections SAE Flare Ø [mm] 1/4"

ODS Ø [in.] -

ODS Ø [mm] -

Kv[m³/h] 0,39

PS[bar] 45

TS[°C] Min -40

TS[°C] Max +110

Package pcs 40

Notes where expressly stated

(1): according to UL approval, 650psi