

Product Code

**3320N/7S**

Crankcase Pressure Regulator

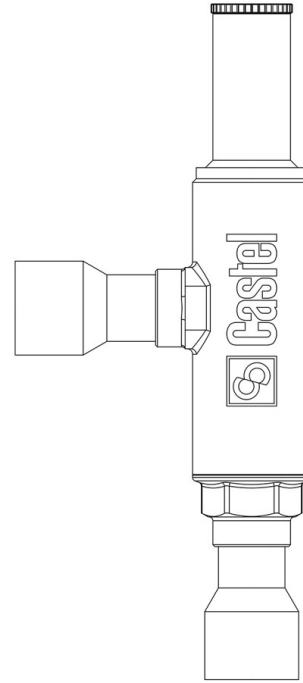

### Product use

These are regulators commonly used in low-temperature refrigeration systems. They are designed to prevent the compressor motor from overloading when the intake pressure exceeds the manufacturers recommended operating pressure.

Accessories for use with the following ASHRAE 34:2019 refrigerants, Class A1, A2L, A3:

HFC (R134A, R32, R404A, R407C, R410A, R507)

HFO (R1234YF, R1234ZE)

HFO + HFC (R448A, R449A, R450A, R452A, R452B, R454A, R454B, R454C, R455A, R513A, R515A, R515B)

HC (R290, R600, R600A, R1270)

### Product Details

Connections SAE Flare -

Connections Ø ODS [in.] 7/8"

Ø ODS [mm] 22

Regulation range [bar] 0,2-6

Kv [m<sup>3</sup>/h] 3,3

PS [bar] 28

MWP [psi] (1) 406

TS [°C] min. -40

TS [°C] max. +130

Package pcs 8

## Notes where expressly stated

(1): according to UL approval