

## Product Code

# 3080/1C

Fusible Plug

1/8"NPT T=79° C<br>PS = 42 bar

CLASSIC

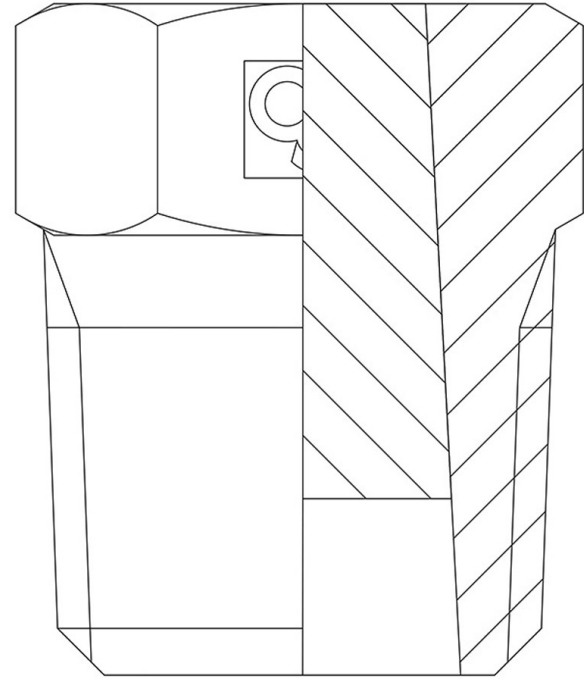

### Product use

Fusible plugs are safety devices that contain a material that melts at a specific temperature and consequently vents the pressure. Safety accessories for use with the following ASHRAE 34:2019 refrigerants, Class A1:

HCFC (R22)

HFC (R134a, R404A, R407C, R410A, R507)

HFO (R1234ze)

HFO + HFC (R448A, R449A, R450A, R452A, R513A, R515A, R515B)

Alloy melting point 79 °C for plugs in series 3080. Alloy melting point 138 °C for plugs in series 3082.

### Product Details

Connections NPT	1/8"
Flow section [mm <sup>2</sup> ]	18,8
Kd	0,91
PS[bar]	42
Melting point [°C]	79
Max operating temperature [°C]	68
Package pcs	0