

## Product Code

# 9185/RA2

Coil Type CM3-N2 UL  
24V 60Hz

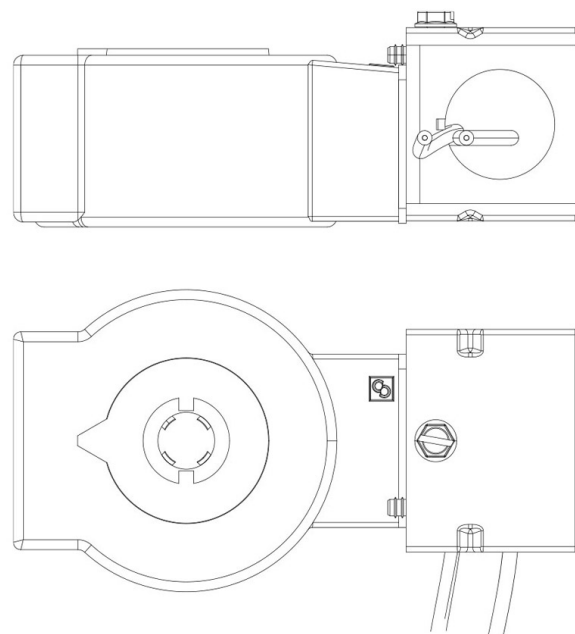

## Product use

Coils with the new FAST LOCK fixing system, series 9320, and coils with gear fixing systems, series 9120 and 9121.

Fast-on connections type DIN 43650/A for coils in series 9120 and 9320; co-moulded cables for series 9121 coils.

Available voltages: 220/230 VAC - 50/60 Hz, 12 VDC, 24 VDC, 27 VDC, 48 VDC.

Connectors in series 9150, normalized DIN 43650, to wire, with IP65 protection rating. Connectors in series 9900, again normalized DIN 43650, pre-wired with various cable lengths, with IP65 protection rating.

## Product Details

<b>Coil Type (1)</b>	CM3-N2
<b>Voltage [V]</b>	24
<b>Frequency [Hz]</b>	60
<b>Power [W]</b>	20
<b>Connectors Type</b>	Junction box NEMA 2153mm cables
<b>Connectors Protection degree</b>	~ IP 12-32
<b>Package Pcs.</b>	21

## Notes where expressly stated

(1): coil with spare part G9150/R97 (yellow nut + black screw + OR)