

Product Code

6110/23

Receiver Valve

1/4"Flarex3/8"NPT
PS = 45 bar

CLASSIC

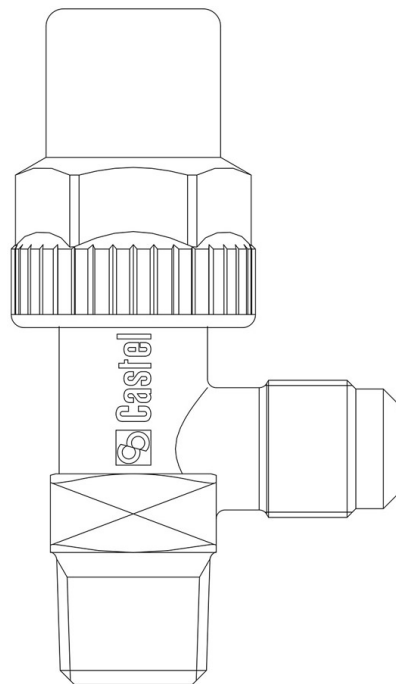

Product use

Accessories for use with the following ASHRAE 34:2019 refrigerants, Class A1:

HCFC (R22)

HFC (R134a, R404A, R407C, R410A, R507)

HFO (R1234ze)

HFO + HFC (R448A, R449A, R450A, R452A, R513A, R515A, R515B)

Product Details

Access fitting SAE Flare -

Connections SAE Flare 1/4"

Connections NPT 3/8"

Kv [m³/h] 0,45

PS [bar] 45

MWP [psi] (2) 650

TS [°C] min. -40

TS [°C] max. +130

Package pcs 90

Notes where expressly stated

(1): can be used without copper gasket

Castel non si assume alcuna responsabilità per eventuali errori nei cataloghi, opuscoli e altro materiale stampato o indicato nel sito Castel.it. Castel si riserva il diritto di modificare i propri prodotti senza preavviso. Tutti i marchi in questo materiale sono di proprietà di Castel. Tutti i diritti riservati.

Castel assumes no responsibility for any errors in catalogs, brochures and other material printed or indicated on the Castel.it website. Castel reserves the right to modify its products without notice. All trademarks in this material are the property of Castel. All rights reserved.

(2): according to UL approval

(3): not UL approved