

Product Code

**9901/X57**

Actuator Adapter

-

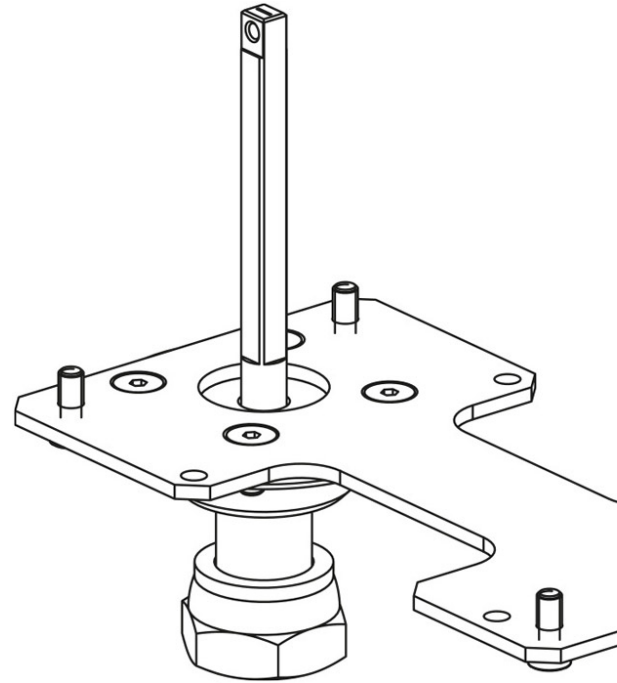

### Product use

Flanged adapters are made by Castel to couple the actuators to the 2-ways ball valves or manual 3-ways ball valves later allowing the conversion from a manual to a motorized valve.

### Product Details

Package Pcs. 1

### Notes where expressly stated

see the couplings indicated in the COUPLING SCHEME table