

Product Code

2028C/M10S04

PWM Expansion Valve

10mmx12mm ODS Seat 04
PS = 90 bar - 1305 psi

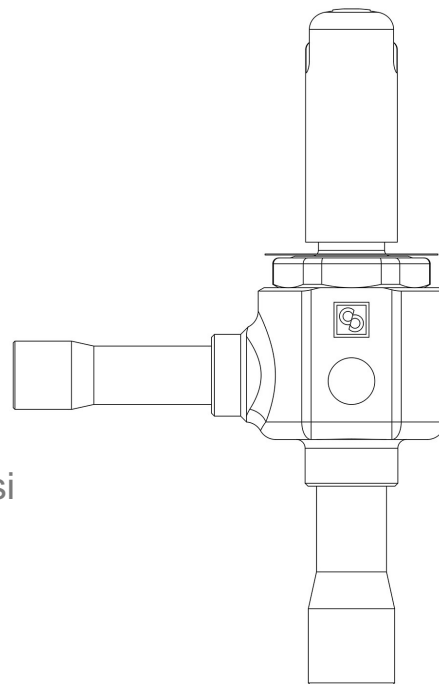

Product use

Accessories for use with the following ASHRAE 34:2019 refrigerants, Class A1, A2L, or A3:

HFC (R134A, R32, R404A, R407C, R410A, R507)

HFO (R1234YF, R1234ZE)

HFO + HFC (R448A, R449A, R450A, R452A, R452B, R454A,

R454B, R454C, R455A, R513A, R515A, R515B)

HC (R290, R600, R600A, R1270)

These valves are only sold in the model without the coil (S suffix), with 9 nozzles assembled for an increasing output from 1 to 22 kW with R410A.

Product Details

Orifice type 04

Connections In Ø [in.] -

Connections In Ø [mm] 10

Out Ø [in.] -

Out Ø [mm] 12

Kv [m³/h] 0,043

PS [bar] 90

MWP [psi] (1) 1305

TS [°C] min. (2) -80

TS [°C] max. +60

Package pcs. 17

Notes where expressly stated

for rated capacities see table of the orifice assemblies

(1): according to UL approval

(2): UL -50°C