

Product Code

2028C/M10S04

PWM Expansion Valve

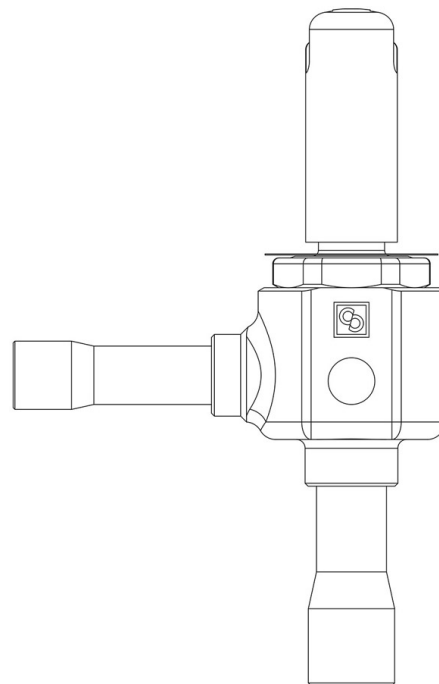

Product use

Accessories for use with the following ASHRAE 34:2019 refrigerants, Class A1:

HCFC (R22)

HFC (R134a, R404A, R407C, R410A, R507)

HFO (R1234ze)

HFO + HFC (R448A, R449A, R450A, R452A, R513A, R515A, R515B)

These valves are only sold in the model without the coil (S suffix), with 9 nozzles assembled for an increasing output from 1 to 22 kW with R410A.

Product Details

Orifice type 04

Connections In Ø [in.] -

Connections In Ø [mm] 10

Out Ø [in.] -

Out Ø [mm] 12

Kv [m³/h] 0,043

PS [bar] 90

MWP [psi] (1) 1305

TS [°C] min. (2) -80

TS [°C] max. +60

Package pcs. 17

Notes where expressly stated

for rated capacities see table of the orifice assemblies

(1): according to UL approval

(2): UL -50°C