

Product Code

**9910/RA2**

Smart Connector Package  
24V 50/60Hz

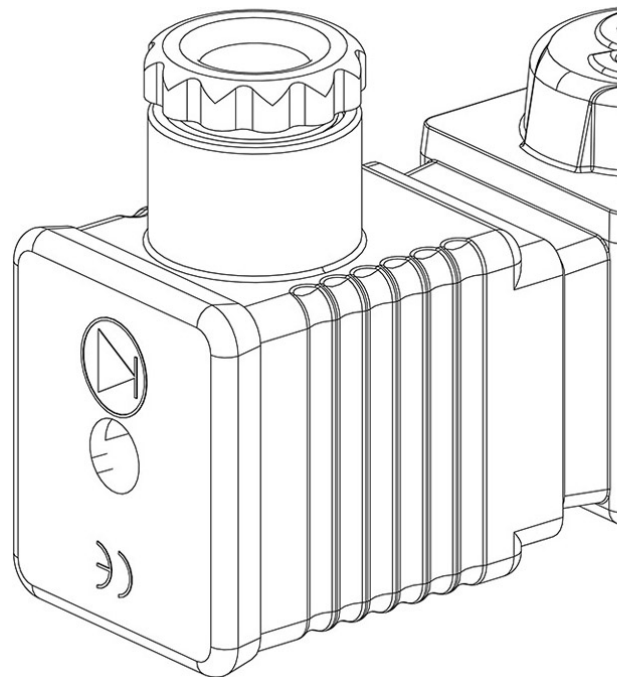

## Product use

The "SMART CONNECTOR" systems series 9910 are formed by coupling a connector in series 9152, equipped with an integrated electronic circuit in the connector, with a specific series 9300 coil designed for the connector. These systems have been designed by Castel to be installed on solenoid expansion valves and they allow for:

- a reduction in energy consumption when fully operational with consequent reduction in operating temperature
- an extension of the coil life
- an increase in the MOPD value of the valve

IP65 protection rating. Available voltages; 24 VAC - 50/60 Hz, 220/230 VAC - 50/60 Hz, 240 VAC - 50/60 Hz, 12 VDC, 24 VDC.

## Product Details

Voltage [V] 24

Frequency [Hz] 50/60

T boost [msec] 200

Power working [W] 7

Power start [W] 50

