

Product Code

1190/6S

Solenoid Valve NO
3/4" Flare w/o Coil
PS = 45 bar

CLASSIC

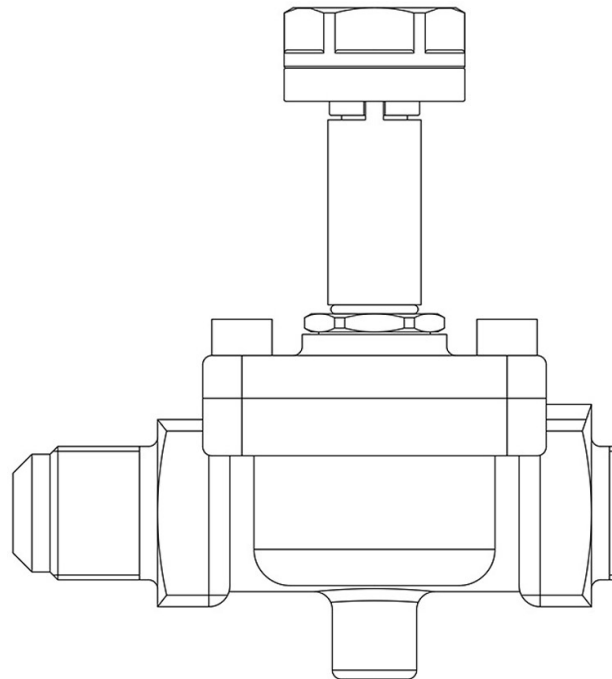

Product use

Accessories for use with the following ASHRAE 34:2019 refrigerants, Class A1:

- HCFC (R22)
- HFC (R134a, R404A, R407C, R410A, or R507)
- HFO and HFO/HFC blends (R1234ze, R448A, R449A, R450A, R452A, R513A)

Maximum allowable pressure PS = 45 bar.

Allowable temperatures TS = -35 / +105 °C (+110 °C for direct opening).

These valves are exclusively sold in the model without coil (S suffix).

Product Details

Operating principle Diaphragm pilot operated

Coil Type (1) HM3

Connections SAE Flare 3/4"

Kv [m³/h] 4,8

PS [bar] 45

TS [°C] min. -35

TS [°C] max. +105

Package Pcs. 14

Notes where expressly stated

The N.O. valves have been designed to work only with direct current coil.

To use them with an alternate current supply it's necessary to mate the N.O. valve with the 9120/RD6 coil

Castel non si assume alcuna responsabilità per eventuali errori nei cataloghi, opuscoli e altro materiale stampato o indicato nel sito Castel.it. Castel si riserva il diritto di modificare i propri prodotti senza preavviso. Tutti i marchi in questo materiale sono di proprietà di Castel. Tutti i diritti riservati.

Castel assumes no responsibility for any errors in catalogs, brochures and other material printed or indicated on the Castel.it website. Castel reserves the right to modify its products without notice. All trademarks in this material are the property of Castel. All rights reserved.

and the connector 9150/R45

(1) : coils that can be mounted on the valves