

Product Code

1034N/3S

Solenoid Valve
3/8" Flare w/o Coil
 PS = 50 bar

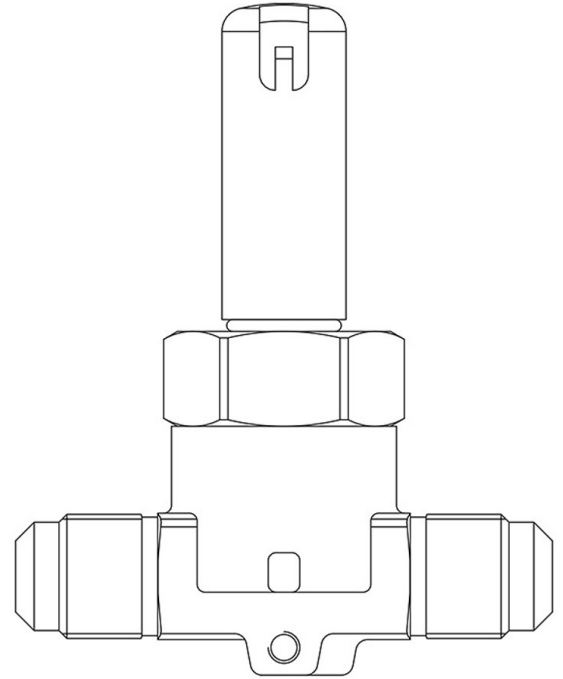

Product use

Accessories for use with the following ASHRAE 34:2019 refrigerants, Class A1, A2L, or A3:

HFC (R134A, R32, R404A, R407C, R410A, R507)

HFO (R1234YF, R1234ZE)

HFO + HFC (R448A, R449A, R450A, R452A, R452B, R454A, R454B, R454C, R455A, R513A, R515A, R515B)

HC (R290, R600, R600A, R1270)

These valves are sold in both the version without the coil (S suffix) and the version with the coil (A6 suffix for coils at 220 VAC).

Product Details

Operating principle	Piston pilot operated
Coil Type (1)	HF2HF3HF4HM2HM3HM4CM2
Connections SAE Flare	3/8"
Kv [m³/h]	1
PS [bar]	50
TS [°C] min.	-40
TS [°C] max.	+130
Package Pcs.	18

Notes where expressly stated

(1) : coils that can be mounted on the valves