

Product Code

3910/66

Moisture Indicator

3/4"Flare M/M
PS = 50 bar - 500 PSI

POLYHEDRA

CLASSIC

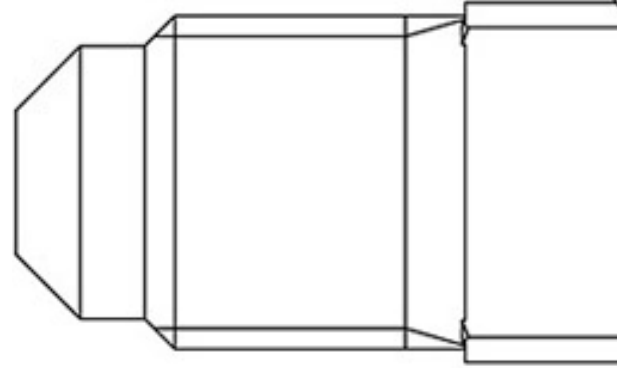

Product use

Accessories for use with the following ASHRAE 34:2019 refrigerants, Class A1, A2L, or A3:

HFC (R134A, R32, R404A, R407C, R410A, R507)

HFO (R1234YF, R1234ZE)

HFO + HFC (R448A, R449A, R450A, R452A, R452B, R454A, R454B, R454C, R455A, R513A, R515A, R515B)

HC (R290, R600, R600A, R1270)

Product Details

Connections SAE Flare 3/4"

Connections Ø ODS [in.] -

Ø ODS [mm] -

PS [bar] 50

MWP [psi] (1) 500

TS[°C] Min -40

TS[°C] Max +120

Package pcs 20

Notes where expressly stated

(1): according to UL approval