

Product Code

9116/RA2

Coil Type CM2 N4 24 Vac UL Recogn.
24V 60Hz

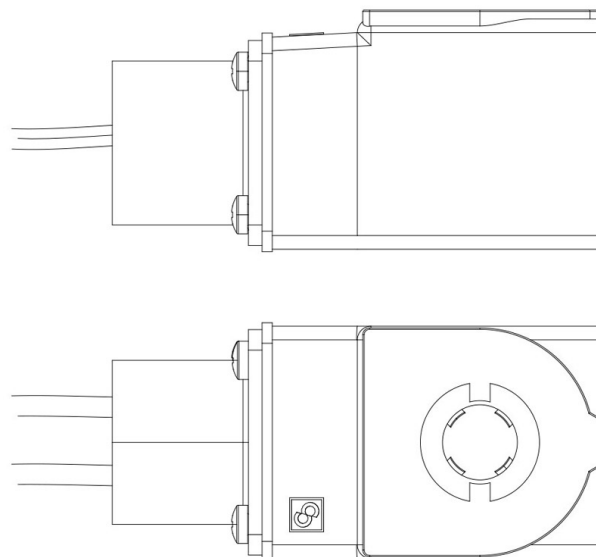

Product use

Coils with gear fixing systems, series 9120 and 9160.

Fast-on connections type DIN 43650/A for coils in series: 9120, 9160. Protection rating IP65; IP68 for series 9160 coils coupled with series 9155 connectors.

Available voltages; 24 VAC - 50/60 Hz, 110 VAC - 50/60 Hz, 220/230 VAC - 50/60 Hz, 240 VAC - 50/60 Hz, 380 VAC - 50/60 Hz, 12 VDC, 24 VDC, 27 VDC.

Connectors in series 9150, normalized DIN 43650, to wire, with IP65 protection rating. Connectors in series 9900, again normalized DIN 43650, pre-wired with various cable lengths, with IP65 protection rating.

Connectors in series 9155, to wire, with IP65/68 protection rating.

Product Details

Coil Type (1)	CM2-N4
Voltage [V]	24
Frequency [Hz]	60
Power [W]	11
Connectors Type	Conduit hub NEMA 4457mm cables
Connectors Protection degree	~ IP 54
Package Pcs.	16

Notes where expressly stated

(1): coil with spare part G9150/R97 (yellow nut + black screw + OR)