

Product Code

6588E/M60

Ball Valve CO2
60mm W
PS = 150 bar - 2176 PSI

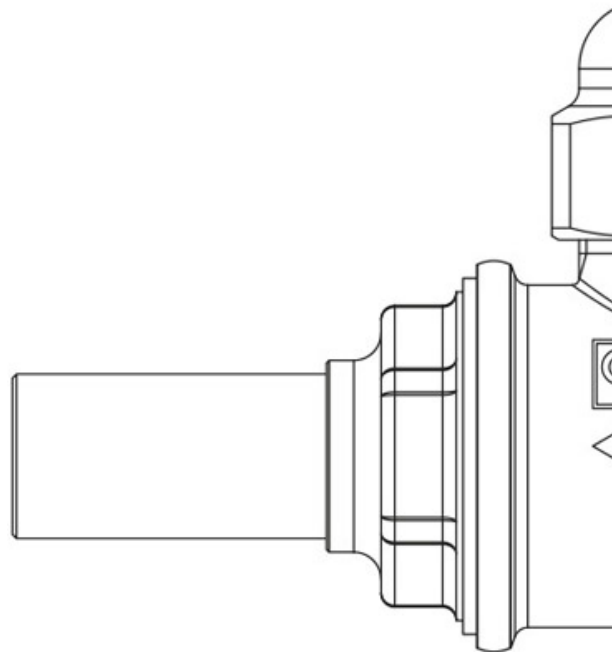

Product use

Accessories for use with refrigerant R744.

Product Details

Connections W Ø [mm] 60,3

Ball port Ø [mm] 50

Kv [m³/h] 214

PS [bar] 150

MWP [psi] (1) 2176

TS [°C] min. -40

TS [°C] max. +150

Package pcs 1

Notes where expressly stated

(1): according to UL approval

NB: proportional flow versions available