

Product Code

6588E/M35

Ball Valve CO2
35mm W
PS = 150 bar - 2176 PSI

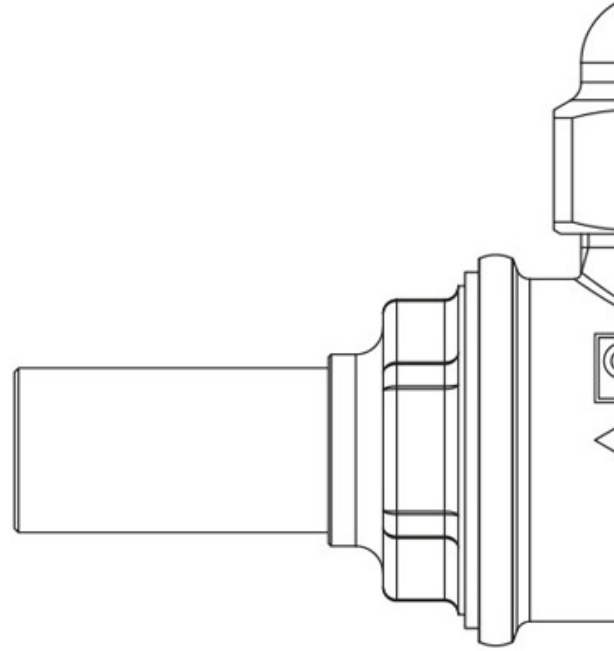

Product use

Accessories for use with refrigerant R744.

Product Details

Connections W Ø [mm]	35
Ball port Ø [mm]	32
Kv [m³/h]	86
PS [bar]	150
MWP [psi] (1)	2176
TS [°C] min.	-40
TS [°C] max.	+150
Package pcs	6

Notes where expressly stated

(1): according to UL approval

NB: proportional flow versions available