

## Product Code

# 6588E/M28A

Ball Valve CO2 Access Port  
28mm W  
PS = 150 bar - 2176 PSI

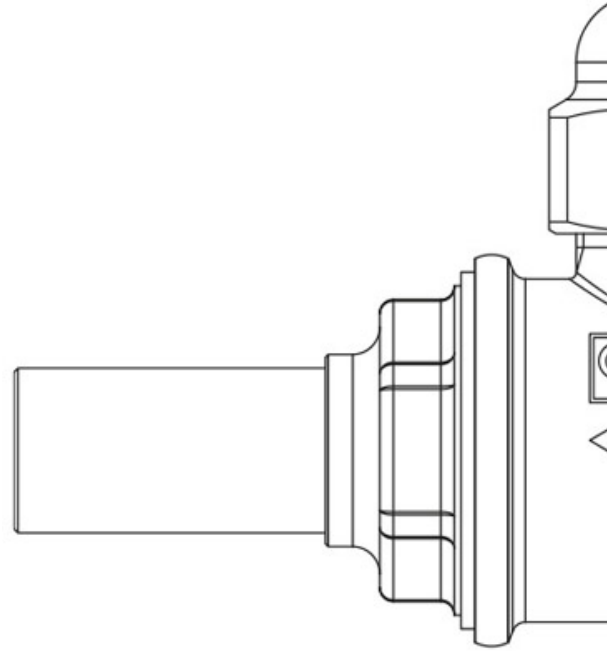

## Product use

Accessories for use with refrigerant R744.

## Product Details

Connections W Ø [mm]	28
Ball port Ø [mm]	25
Kv [m <sup>3</sup> /h]	51
PS [bar]	150
MWP [psi] (1)	2176
TS [°C] min.	-40
TS [°C] max.	+150
Package pcs	8

## Notes where expressly stated

(1): according to UL approval

NB: proportional flow versions available