

Product Code

6588E/M18

Ball Valve CO2

18mm W
PS = 150 bar - 2176 PSI

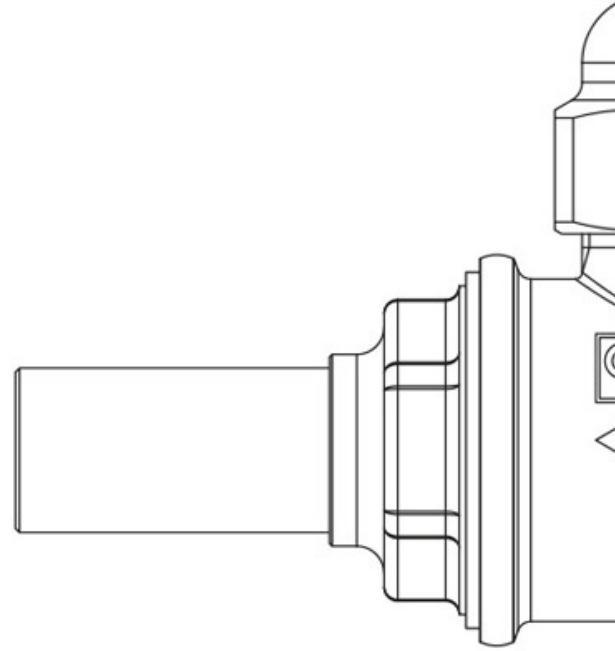

Product use

Accessories for use with refrigerant R744.

Product Details

Connections W Ø [mm]	18
Ball port Ø [mm]	15
Kv [m ³ /h]	17
PS [bar]	150
MWP [psi] (1)	2176
TS [°C] min.	-40
TS [°C] max.	+150
Package pcs	16

Notes where expressly stated

(1): according to UL approval

NB: proportional flow versions available