

Product Code

6588E/M12

Ball Valve CO2

12mm W
PS = 150 bar - 2176 PSI

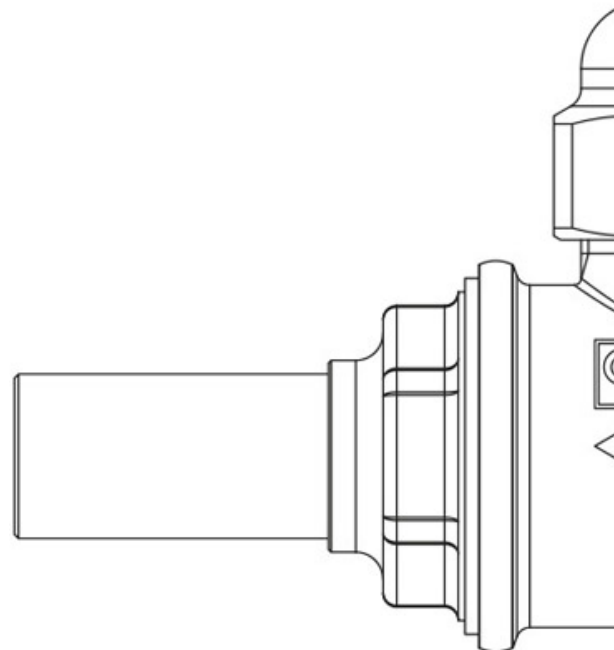

Product use

Accessories for use with refrigerant R744.

Product Details

Connections W Ø [mm]	12
Ball port Ø [mm]	10
Kv [m ³ /h]	5
PS [bar]	150
MWP [psi] (1)	2176
TS [°C] min.	-40
TS [°C] max.	+150
Package pcs	25

Notes where expressly stated

(1): according to UL approval

NB: proportional flow versions available