

Product Code

6531 E/M12

Ball Valve W/Check Valve CO2

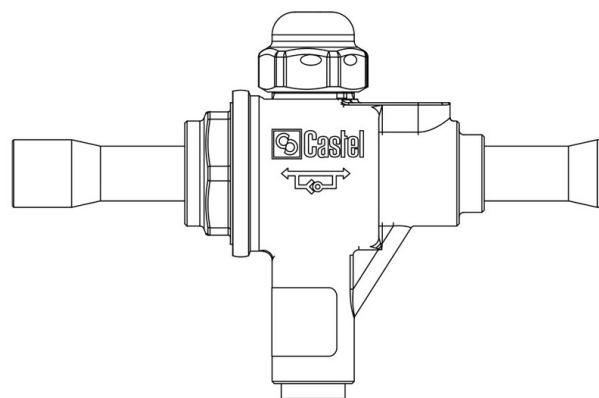

Product use

Accessories for use with refrigerant R744.

Product Details

Connections ODS Ø [in.]	-
Connections ODS Ø [mm]	12
Ball port Ø [mm]	15
Kv [m ³ /h]	5
PS [bar]	90
MWP [psi] (1)	1305
TS [°C] min.	-40
TS [°C] max.	+150
Package pcs	24

Notes where expressly stated

(1): according to UL approval

Bypass MinOPD = 0,1bar

Bypass Kv = 0,14m³/h