

Product Code

**6690NM/9A6**

3-Ways Motorized Ball Valve Polyhedra  
1.1/8" ODS <br> PS = 50 bar

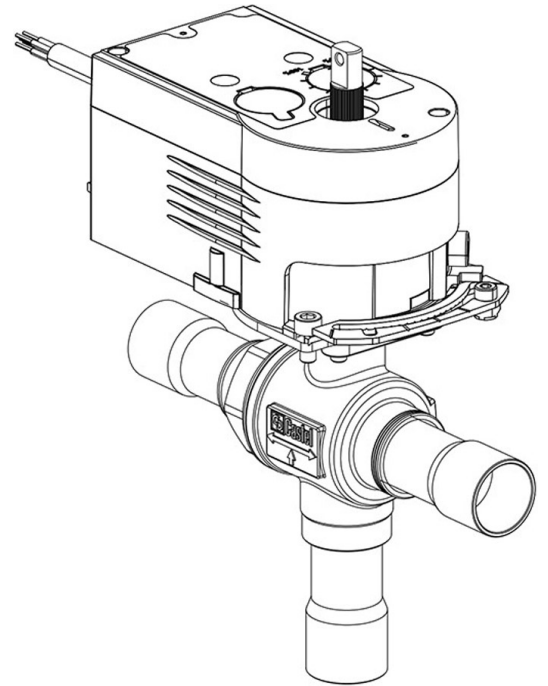

**P O L Y H E D R A**

### Product use

Accessories for use with the following ASHRAE 34:2019 refrigerants, Class A1, A2L, A3:

HFC (R134A, R32, R404A, R407C, R410A, R507)

HFO (R1234YF, R1234ZE)

HFO + HFC (R448A, R449A, R450A, R452A, R452B, R454A, R454B, R454C, R455A, R513A, R515A, R515B)

HC (R290, R600, R600A, R1270)

### Product Details

Part number (1) 6690NM/9A6

Part number (1)

Connections ODS Ø [in.] 1.1/8"

Connections ODS Ø [mm]

P/N Servomotor 9700/RA6

Torque [Nm] 10

Ball port Ø [mm] 24

Kv [m<sup>3</sup>/h] 15,9

PS [bar] 50

TS [°C] min. -40

TS [°C] max. +150

Package pcs 1

Castel non si assume alcuna responsabilità per eventuali errori nei cataloghi, opuscoli e altro materiale stampato o indicato nel sito Castel.it. Castel si riserva il diritto di modificare i propri prodotti senza preavviso. Tutti i marchi in questo materiale sono di proprietà di Castel. Tutti i diritti riservati.

Castel assumes no responsibility for any errors in catalogs, brochures and other material printed or indicated on the Castel.it website. Castel reserves the right to modify its products without notice. All trademarks in this material are the property of Castel. All rights reserved.

## Notes where expressly stated

NB: proportional flow versions available  
(1): with servomotor and mounting plate