

Product Code

6698EM/M42A6

3-Ways Motorized Ball Valve CO2
42,2mm W 230V
PS = 140 bar

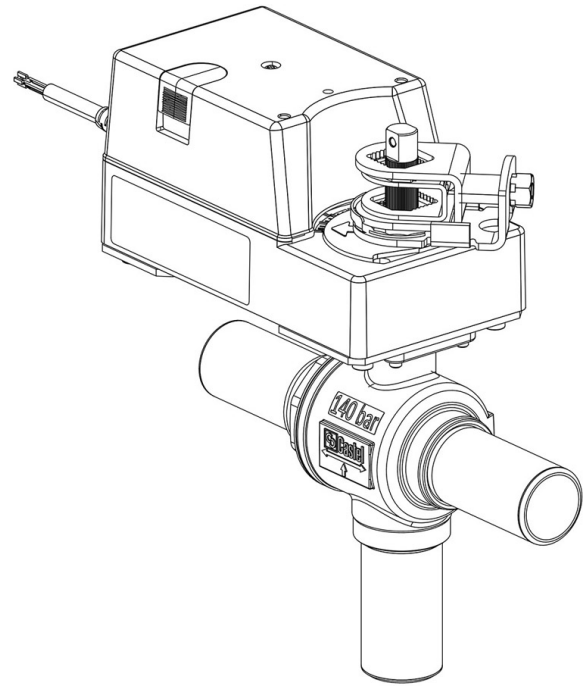

Product use

Accessories for use with refrigerant R744.

Product Details

Part number (1) 6698EM/M42A6

Part number (1)

Connections ODS Ø [in.] -

Connections ODS Ø [mm] -

W Ø [mm] 42

P/N Actuator 9720/RA6

Torque [Nm] 30

Ball port Ø [mm] 37

Kv [m³/h] 38,5

PS [bar] 140

TS [°C] min. -40

TS [°C] max. +150

Package pcs 1

Notes where expressly stated

(1): including actuator and mounting plate

NB: proportional flow versions available