

Product Code

6698EM/M18A2

18mm W 24V

18mm W 24V
PS = 140 bar

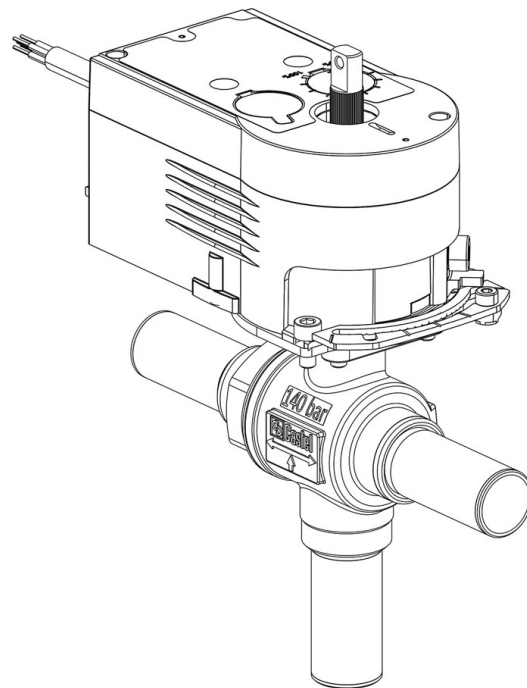

Product use

Accessories for use with refrigerant R744.

Product Details

Part number (1) 6698EM/M18A2

Part number (1) NEW

Connections ODS Ø [in.] -

Connections ODS Ø [mm] -

W Ø [mm] 18

P/N Actuator 9700/RA2

Torque [Nm] 10

Ball port Ø [mm] 13,5

Kv [m³/h] 4,6

PS [bar] 140

TS [°C] min. -40

TS [°C] max. +150

Package pcs 1

Notes where expressly stated

(1): including actuator and mounting plate

NB: proportional flow versions available

Castel non si assume alcuna responsabilità per eventuali errori nei cataloghi, opuscoli e altro materiale stampato o indicato nel sito Castel.it. Castel si riserva il diritto di modificare i propri prodotti senza preavviso. Tutti i marchi in questo materiale sono di proprietà di Castel. Tutti i diritti riservati.

Castel assumes no responsibility for any errors in catalogs, brochures and other material printed or indicated on the Castel.it website. Castel reserves the right to modify its products without notice. All trademarks in this material are the property of Castel. All rights reserved.