

Product Code

6698E/M42

3-Ways Manual Ball Valve CO2
42,2mm W
PS = 140 bar

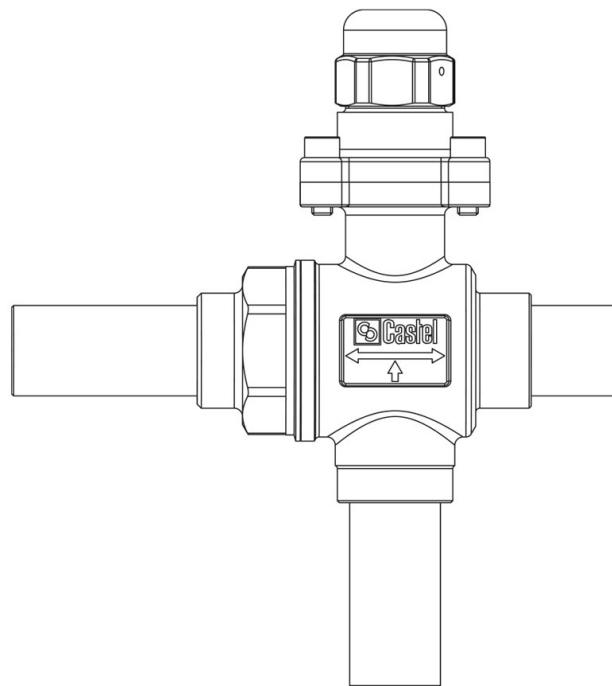

Product use

Accessories for use with refrigerant R744.

Product Details

Connections ODS Ø [mm]	42
Kv [m ³ /h]	38,5
PS [bar]	140
MWP [psi] (1)	(2)
TS [°C] min.	-40
TS [°C] max.	+150
Package pcs	1

Notes where expressly stated

NB: proportional flow versions available

(1): according to UL approval

(2): not UL approved

(3): UL approval ongoing